

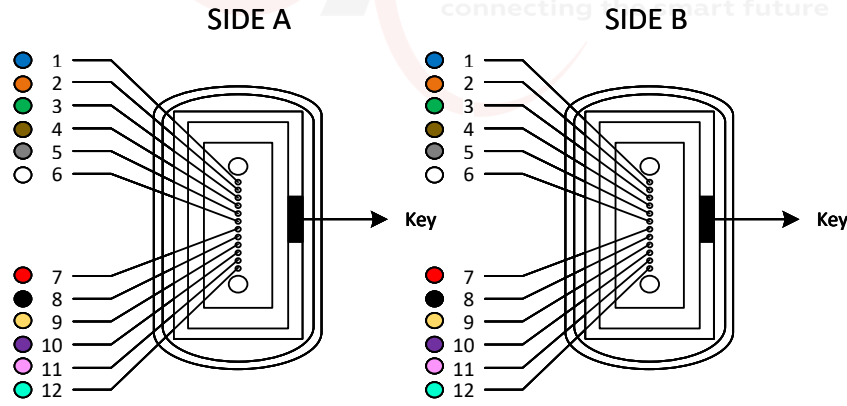

Type A (TIA)

Fiber No.		Color
SIDE A	SIDE B	
1	1	BLUE
2	2	ORANGE
3	3	GREEN
4	4	BROWN
5	5	GRAY
6	6	WHITE
7	7	RED
8	8	BLACK
9	9	YELLOW
10	10	VIOLET
11	11	PINK
12	12	AQUA



Specification:

- 1.Low Loss IL: $\leq 0.35\text{dB}$
- 2.Return Loss: $\geq 35\text{dB}$
- 3.Operation Environment: $-40\sim+85^{\circ}\text{C}$
- 4.Storage Environment: $-40\sim+85^{\circ}\text{C}$

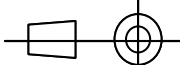

SHENZHEN OPTICO COMMUNICATION CO., LTD.

Model	12F MTPUPC Female-MTPUPC Female Type A MM OM3/4 3.0mm Aqua LSZH CPR-Dca Cable	OP-12F-MTPFUPC-FP-MM-A							
FIRST ANGLE PROJECTION 	MATERIAL	UNIT	SCALE	SIZE	SHEET	DRAWN	XUELING W	DATE	2025.04.25
	LSZH	m	/	A4	1	CHECKED	Michael Liu	DATE	2025.04.25
							APPROVED	STEVEN Zhang	DATE

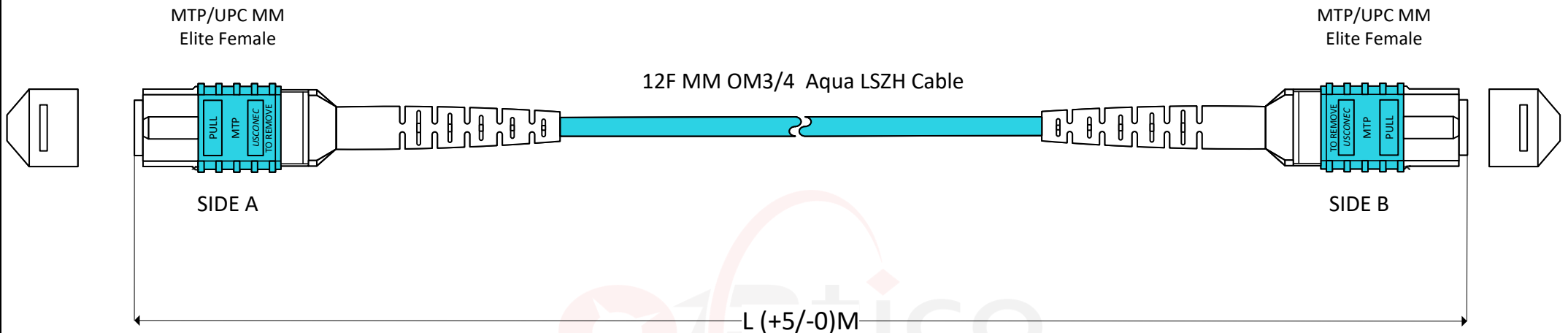

Type B (TIA)

Fiber No.		Color
SIDE A	SIDE B	
1	12	BLUE
2	11	ORANGE
3	10	GREEN
4	9	BROWN
5	8	GRAY
6	7	WHITE
7	6	RED
8	5	BLACK
9	4	YELLOW
10	3	VIOLET
11	2	PINK
12	1	AQUA

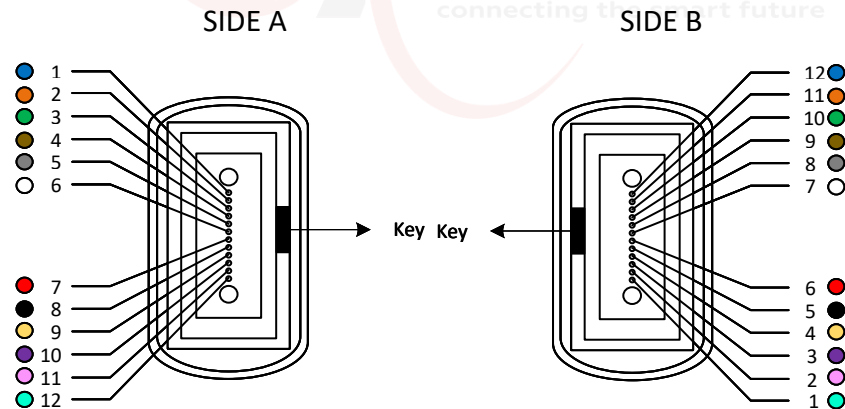

Specification:

- 1.Low Loss IL: $\leq 0.35\text{dB}$
- 2.Return Loss: $\geq 35\text{dB}$
- 3.Operation Environment: $-40\sim+85^{\circ}\text{C}$
- 4.Storage Environment: $-40\sim+85^{\circ}\text{C}$



SHENZHEN OPTICO COMMUNICATION CO., LTD.

Model	12F MTUPC Female-MTUPC Female Type B MM OM3/4 3.0mm Aqua LSZH CPR-Dca Cable					OP-12F-MTPFUPC-FP-MM-B			
FIRST ANGLE PROJECTION	MATERIAL	UNIT	SCALE	SIZE	SHEET	DRAWN	XUELING W	DATE	2025.04.25
	LSZH	m		A4	1	CHECKED	Michael Liu	DATE	2025.04.25
						APPROVED	STEVEN Zhang	DATE	2025.04.25

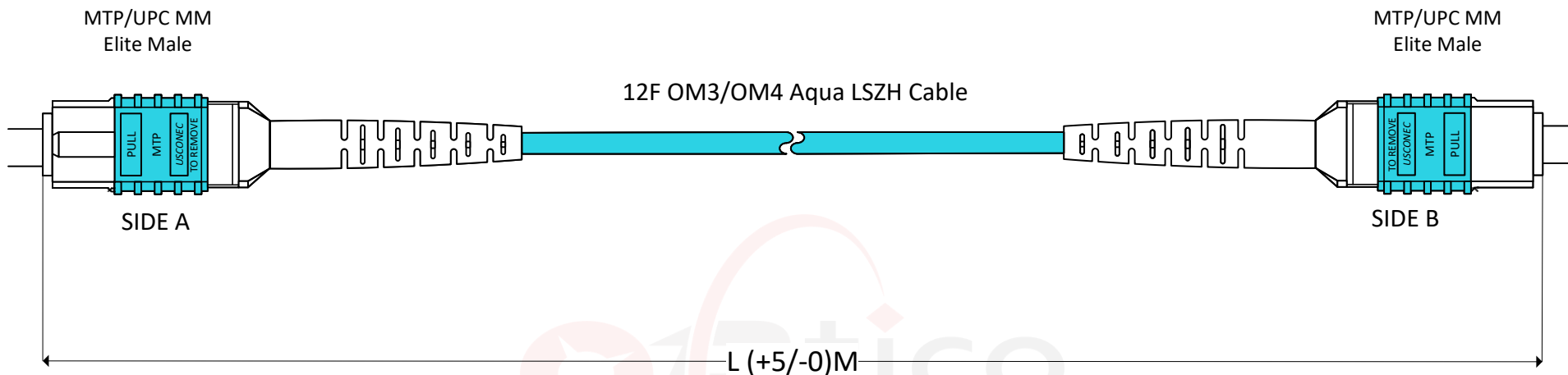

Type A (TIA)

Fiber No.		Color
SIDE A	SIDE B	
1	1	BLUE
2	2	ORANGE
3	3	GREEN
4	4	BROWN
5	5	GRAY
6	6	WHITE
7	7	RED
8	8	BLACK
9	9	YELLOW
10	10	VIOLET
11	11	PINK
12	12	AQUA

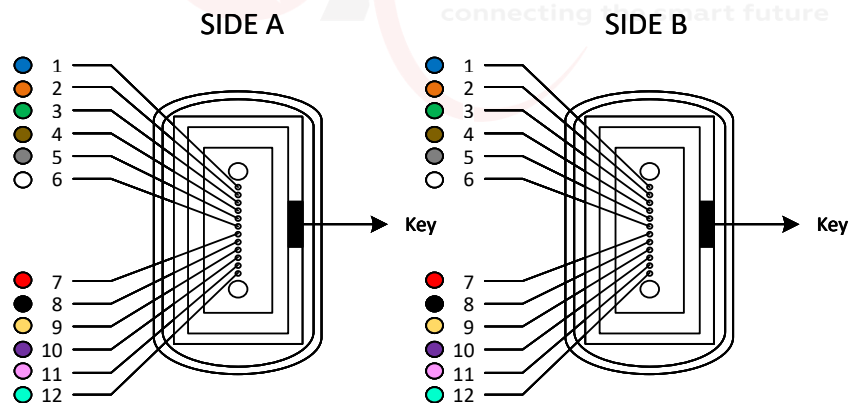

Specification:

- 1.Low Loss IL: $\leq 0.35\text{dB}$
- 2.Return Loss: $\geq 35\text{dB}$
- 3.Operation Environment: $-40\sim+85^{\circ}\text{C}$
- 4.Storage Environment: $-40\sim+85^{\circ}\text{C}$



SHENZHEN OPTICO COMMUNICATION CO., LTD.

Model	12F MTPUPC Male-MTPUPC Male Type A MM OM3/4 3.0mm Aqua LSZH CPR-Dca Cable					OP-12F-MTPMUPC-FP-MM-A			
FIRST ANGLE PROJECTION	MATERIAL	UNIT	SCALE	SIZE	SHEET	DRAWN	XUELING W	DATE	2025.04.25
	LSZH	m	/	A4	1	CHECKED	Michael Liu	DATE	2025.04.25
						APPROVED	STEVEN Zhang	DATE	2025.04.25

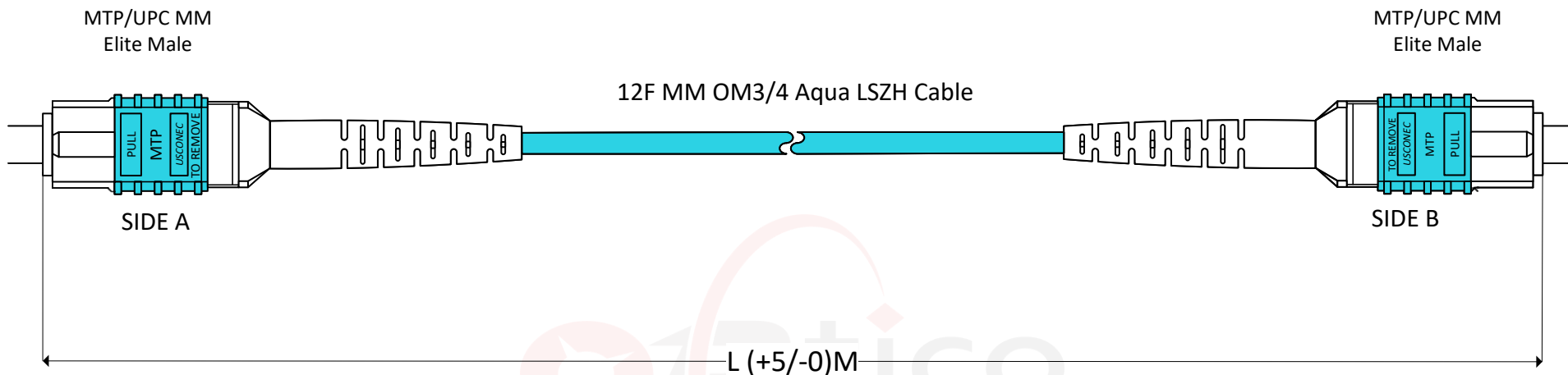

Type B (TIA)

Fiber No.		Color
SIDE A	SIDE B	
1	12	BLUE
2	11	ORANGE
3	10	GREEN
4	9	BROWN
5	8	GRAY
6	7	WHITE
7	6	RED
8	5	BLACK
9	4	YELLOW
10	3	VIOLET
11	2	PINK
12	1	AQUA

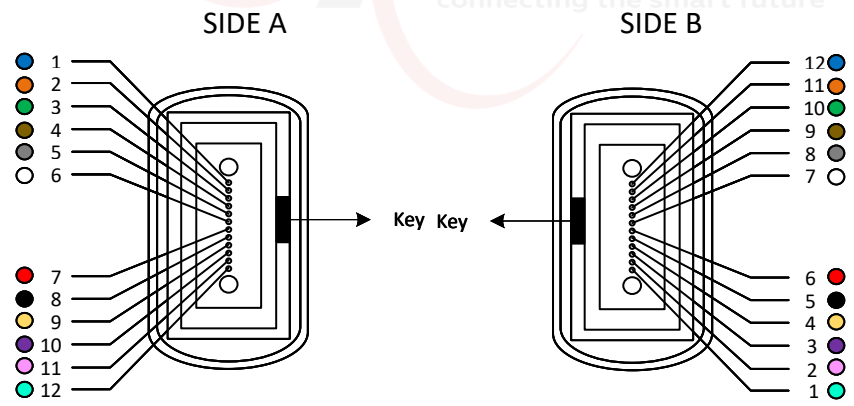

Specification:

- 1.Low Loss IL: $\leq 0.35\text{dB}$
- 2.Return Loss: $\geq 35\text{dB}$
- 3.Operation Environment: $-40\sim+85^{\circ}\text{C}$
- 4.Storage Environment: $-40\sim+85^{\circ}\text{C}$

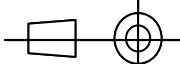

SHENZHEN OPTICO COMMUNICATION CO., LTD.

Model	12F MTPUPC Male-MTPUPC Male Type B MM OM3/4 3.0mm Aqua LSZH CPR-Dca Cable					OP-12F-MTPMUPC-FP-MM-B			
FIRST ANGLE PROJECTION 	MATERIAL	UNIT	SCALE	SIZE	SHEET	DRAWN	XUELING W	DATE	2025.04.25
	LSZH	m	/	A4	1	CHECKED	Michael Liu	DATE	2025.04.25
						APPROVED	STEVEN Zhang	DATE	2025.04.25

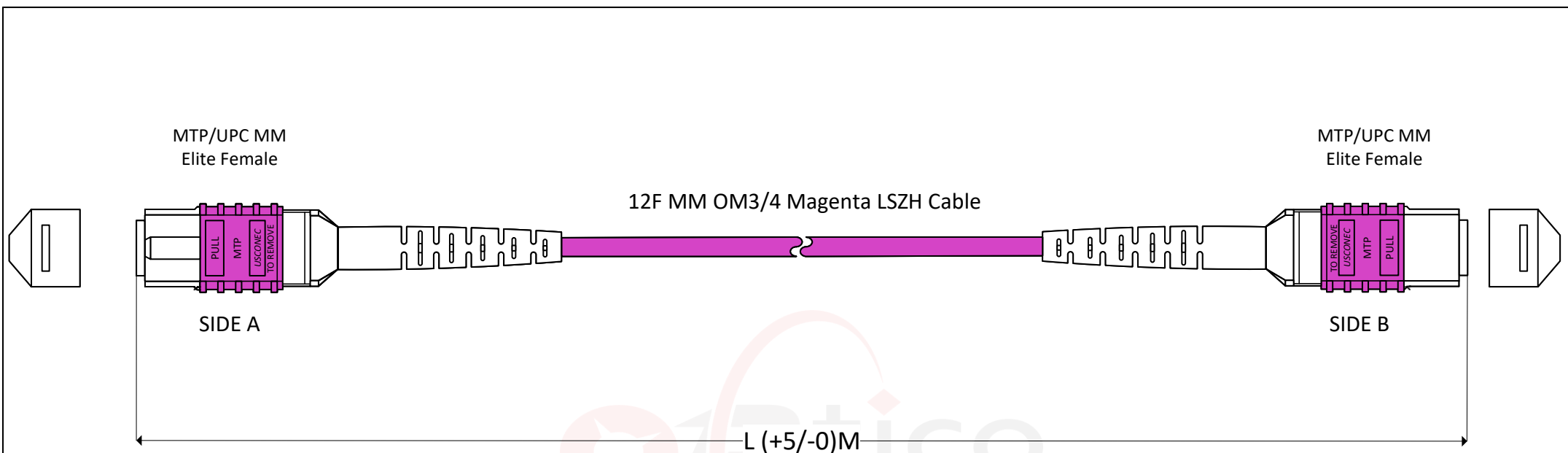

Type A (TIA)

Fiber No.		Color
SIDE A	SIDE B	
1	1	BLUE
2	2	ORANGE
3	3	GREEN
4	4	BROWN
5	5	GRAY
6	6	WHITE
7	7	RED
8	8	BLACK
9	9	YELLOW
10	10	VIOLET
11	11	PINK
12	12	AQUA

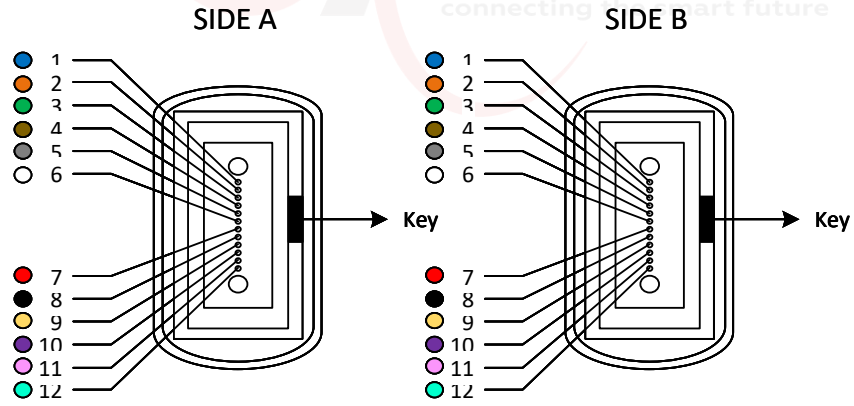

Specification:

- 1.Low Loss IL: $\leq 0.35\text{dB}$
- 2.Return Loss: $\geq 35\text{dB}$
- 3.Operation Environment: $-40\sim+85^{\circ}\text{C}$
- 4.Storage Environment: $-40\sim+85^{\circ}\text{C}$

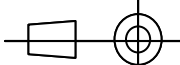
		SHENZHEN OPTICO COMMUNICATION CO., LTD.							
Model		12F MTPUPC Female-MTPUPC Female Type A MM OM3/4 3.0mm Magenta LSZH CPR-Dca Cable					OP-12F-MTPFUPC-FP-MM-A		
FIRST ANGLE PROJECTION 	MATERIAL	UNIT	SCALE	SIZE	SHEET	DRAWN	XUELING W	DATE	2025.04.25
	LSZH	m		A4	1	CHECKED	Michael Liu	DATE	2025.04.25
						APPROVED	STEVEN Zhang	DATE	2025.04.25

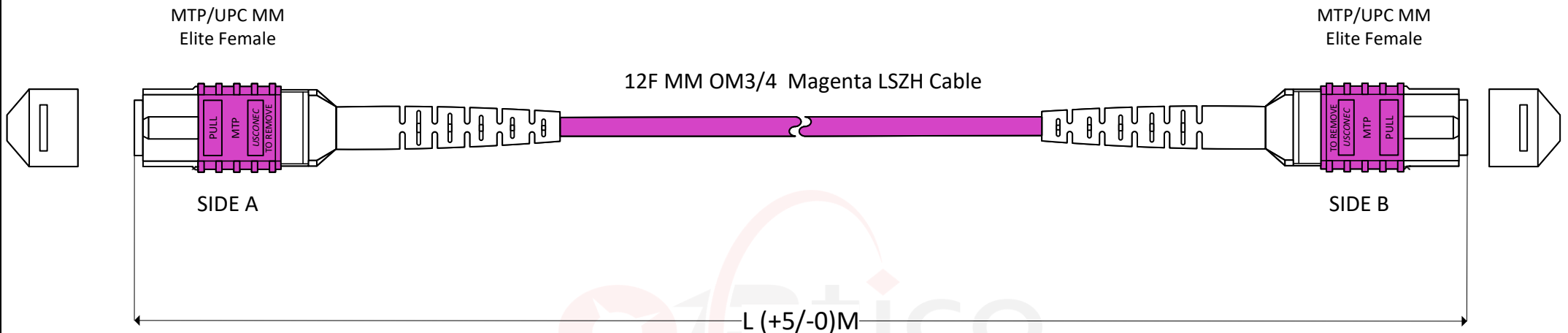

Type B (TIA)

Fiber No.		Color
SIDE A	SIDE B	
1	12	BLUE
2	11	ORANGE
3	10	GREEN
4	9	BROWN
5	8	GRAY
6	7	WHITE
7	6	RED
8	5	BLACK
9	4	YELLOW
10	3	VIOLET
11	2	PINK
12	1	AQUA

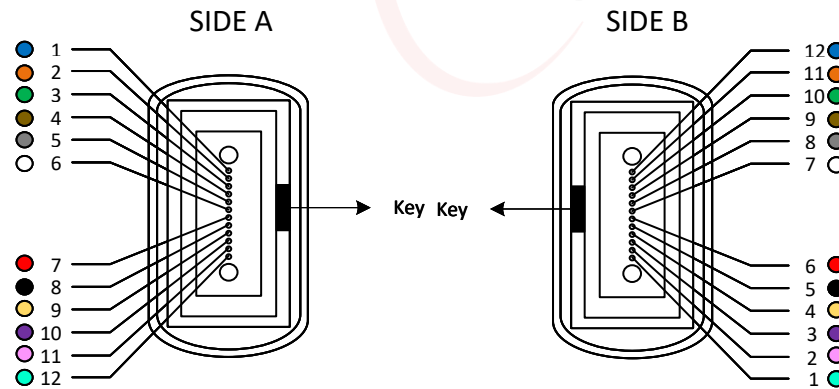

Specification:

- 1.Low Loss IL: $\leq 0.35\text{dB}$
- 2.Return Loss: $\geq 35\text{dB}$
- 3.Operation Environment: $-40\sim+85^{\circ}\text{C}$
- 4.Storage Environment: $-40\sim+85^{\circ}\text{C}$



SHENZHEN OPTICO COMMUNICATION CO., LTD.

Model	12F MTPUPC Female-MTPUPC Female Type B MM OM3/4 3.0mm Magenta LSZH CPR-Dca Cable					OP-12F-MTPFUPC-FP-MM-B			
FIRST ANGLE PROJECTION	MATERIAL	UNIT	SCALE	SIZE	SHEET	DRAWN	XUELING W	DATE	2025.04.25
	LSZH	m	/	A4	1	CHECKED	Michael Liu	DATE	2025.04.25
						APPROVED	STEVEN Zhang	DATE	2025.04.25

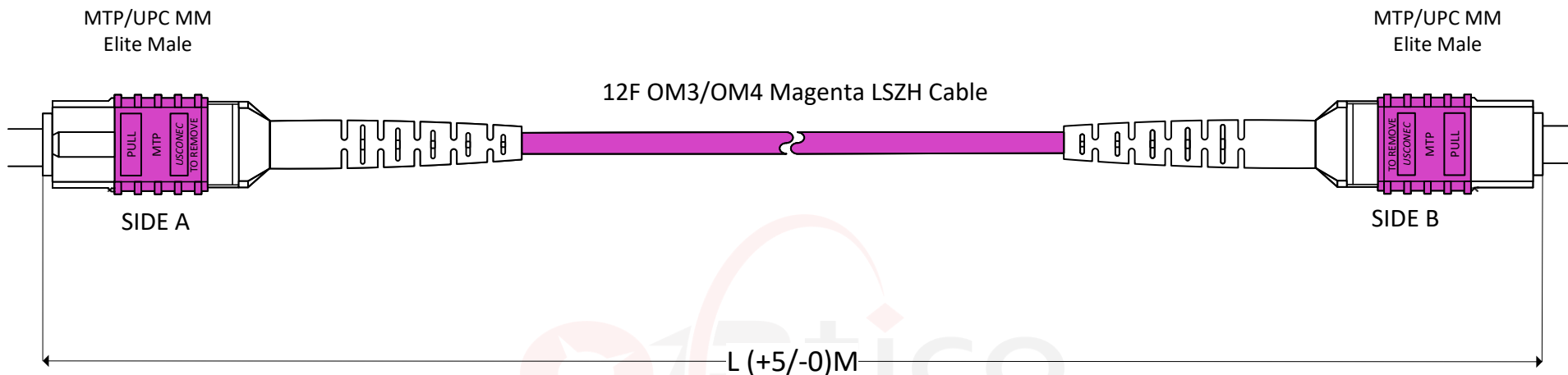

Type A (TIA)

Fiber No.		Color
SIDE A	SIDE B	
1	1	BLUE
2	2	ORANGE
3	3	GREEN
4	4	BROWN
5	5	GRAY
6	6	WHITE
7	7	RED
8	8	BLACK
9	9	YELLOW
10	10	VIOLET
11	11	PINK
12	12	AQUA

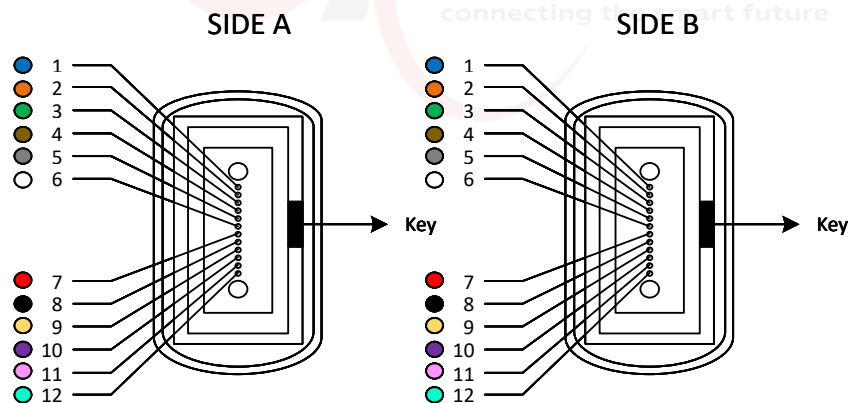

Specification:

- 1.Low Loss IL: $\leq 0.35\text{dB}$
- 2.Return Loss: $\geq 35\text{dB}$
- 3.Operation Environment: $-40\sim+85^{\circ}\text{C}$
- 4.Storage Environment: $-40\sim+85^{\circ}\text{C}$



SHENZHEN OPTICO COMMUNICATION CO., LTD.

Model	12F MTPUPC Male-MTPUPC Male Type A MM OM3/4 3.0mm Magenta LSZH CPR-Dca Cable					OP-12F-MTPMUPC-FP-MM-A			
FIRST ANGLE PROJECTION	MATERIAL	UNIT	SCALE	SIZE	SHEET	DRAWN	XUELING W	DATE	2025.04.25
	LSZH	m	/	A4	1	CHECKED	Michael Liu	DATE	2025.04.25
						APPROVED	STEVEN Zhang	DATE	2025.04.25

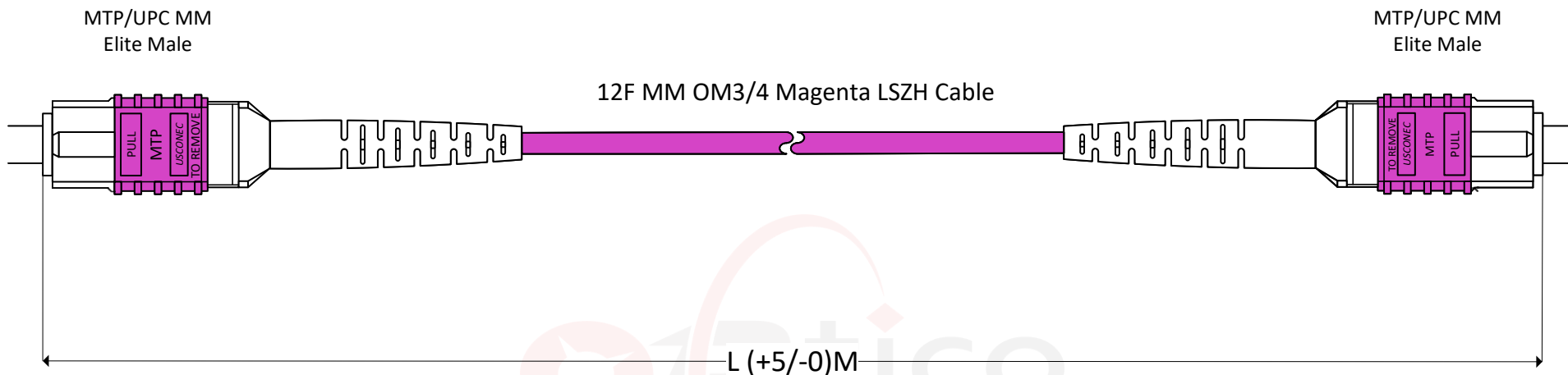

Type B (TIA)

Fiber No.		Color
SIDE A	SIDE B	
1	12	BLUE
2	11	ORANGE
3	10	GREEN
4	9	BROWN
5	8	GRAY
6	7	WHITE
7	6	RED
8	5	BLACK
9	4	YELLOW
10	3	VIOLET
11	2	PINK
12	1	AQUA

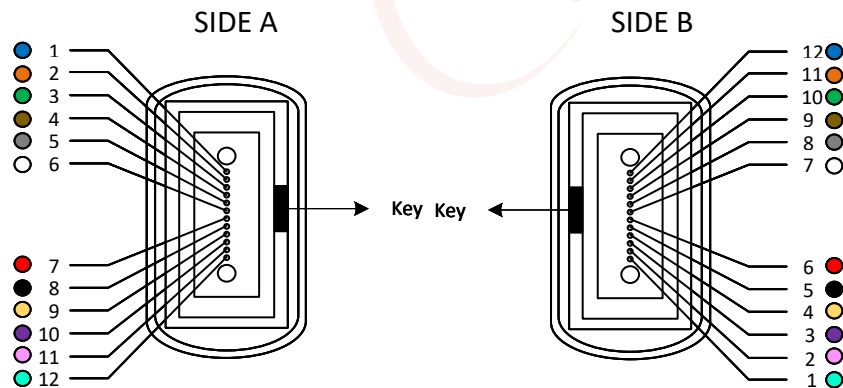

Specification:

- 1.Low Loss IL: $\leq 0.35\text{dB}$
- 2.Return Loss: $\geq 35\text{dB}$
- 3.Operation Environment: $-40\sim+85^{\circ}\text{C}$
- 4.Storage Environment: $-40\sim+85^{\circ}\text{C}$



SHENZHEN OPTICO COMMUNICATION CO., LTD.

Model	12F MTPUPC Male-MTPUPC Male Type B MM OM3/4 3.0mm Magenta LSZH CPR-Dca Cable					OP-12F-MTPMUPC-FP-MM-B			
FIRST ANGLE PROJECTION	MATERIAL	UNIT	SCALE	SIZE	SHEET	DRAWN	XUELING W	DATE	2025.04.25
	LSZH	m	/	A4	1	CHECKED	Michael Liu	DATE	2025.04.25
						APPROVED	STEVEN Zhang	DATE	2025.04.25

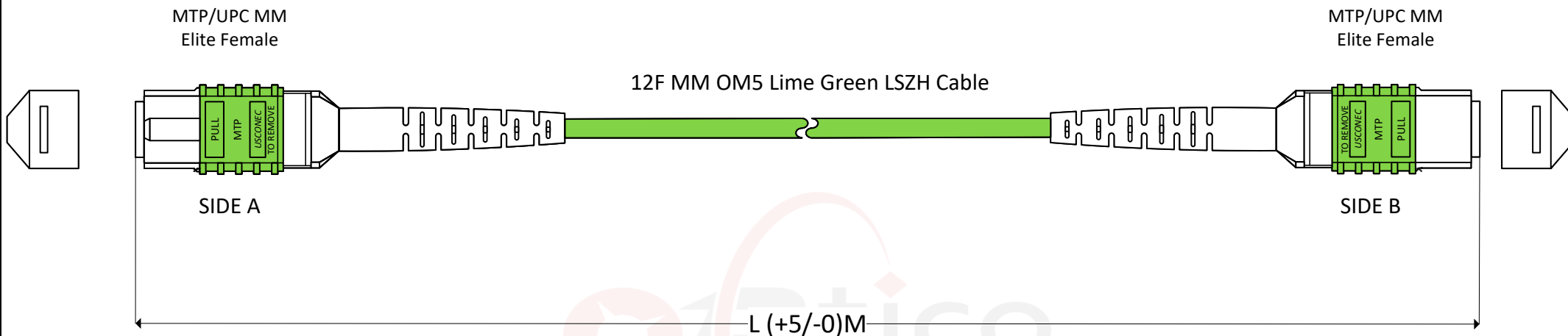

Type A (TIA)

Fiber No.		Color
SIDE A	SIDE B	
1	1	BLUE
2	2	ORANGE
3	3	GREEN
4	4	BROWN
5	5	GRAY
6	6	WHITE
7	7	RED
8	8	BLACK
9	9	YELLOW
10	10	VIOLET
11	11	PINK
12	12	AQUA

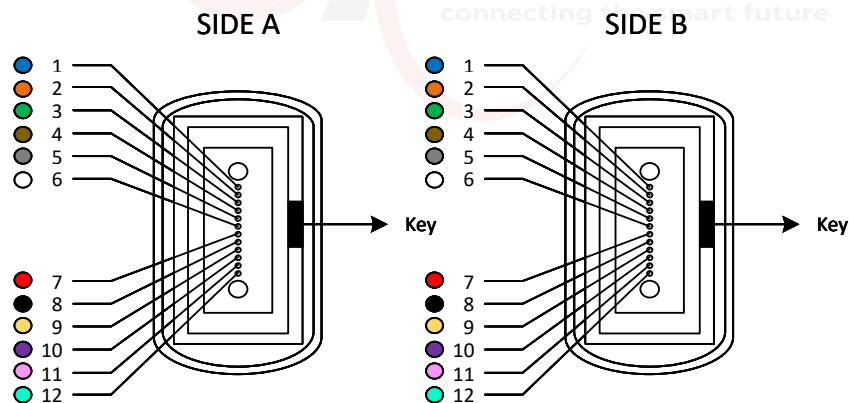

Specification:

- 1.Low Loss IL: $\leq 0.35\text{dB}$
- 2.Return Loss: $\geq 35\text{dB}$
- 3.Operation Environment: $-40\sim+85^{\circ}\text{C}$
- 4.Storage Environment: $-40\sim+85^{\circ}\text{C}$

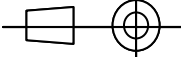
		SHENZHEN OPTICO COMMUNICATION CO., LTD.								
Model		12F MTPUPC Female-MTPUPC Female Type A MM OM5 Lime Green LSZH CPR-Dca Cable					OP-12F-MTPFUPC-FP-MM-A			
FIRST ANGLE PROJECTION 	MATERIAL	UNIT	SCALE	SIZE	SHEET	DRAWN	XUELING W	DATE	2025.04.25	
	LSZH	m	/	A4	1	CHECKED	Michael Liu	DATE	2025.04.25	
						APPROVED	STEVEN Zhang	DATE	2025.04.25	

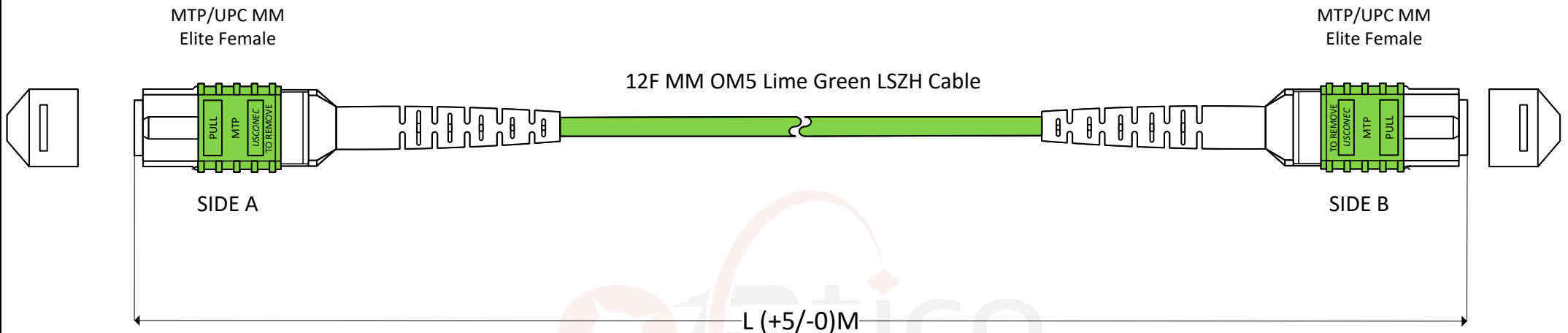

Type B (TIA)

Fiber No.		Color
SIDE A	SIDE B	
1	12	BLUE
2	11	ORANGE
3	10	GREEN
4	9	BROWN
5	8	GRAY
6	7	WHITE
7	6	RED
8	5	BLACK
9	4	YELLOW
10	3	VIOLET
11	2	PINK
12	1	AQUA

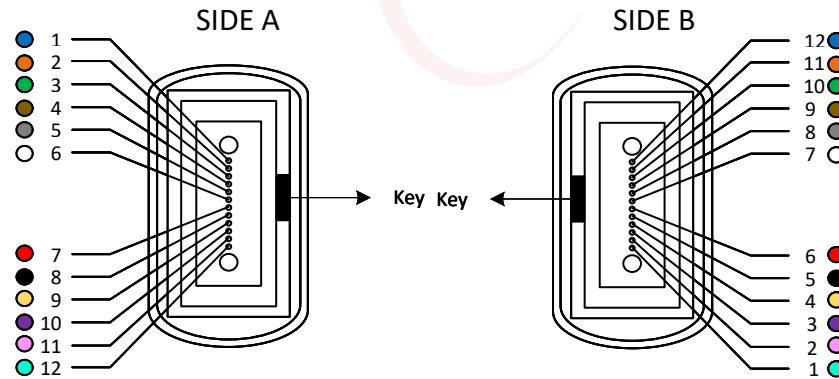

Specification:

- 1.Low Loss IL: $\leq 0.35\text{dB}$
- 2.Return Loss: $\geq 35\text{dB}$
- 3.Operation Environment: $-40\sim+85^{\circ}\text{C}$
- 4.Storage Environment: $-40\sim+85^{\circ}\text{C}$



SHENZHEN OPTICO COMMUNICATION CO., LTD.

Model	12F MTPUPC Female-MTPUPC Female Type B MM OM5 Lime Green LSZH CPR-Dca Cable					OP-12F-MTPFUPC-FP-MM-B			
FIRST ANGLE PROJECTION	MATERIAL	UNIT	SCALE	SIZE	SHEET	DRAWN	XUELING W	DATE	2025.04.25
	LSZH	m	/	A4	1	CHECKED	Michael Liu	DATE	2025.04.25
						APPROVED	STEVEN Zhang	DATE	2025.04.25

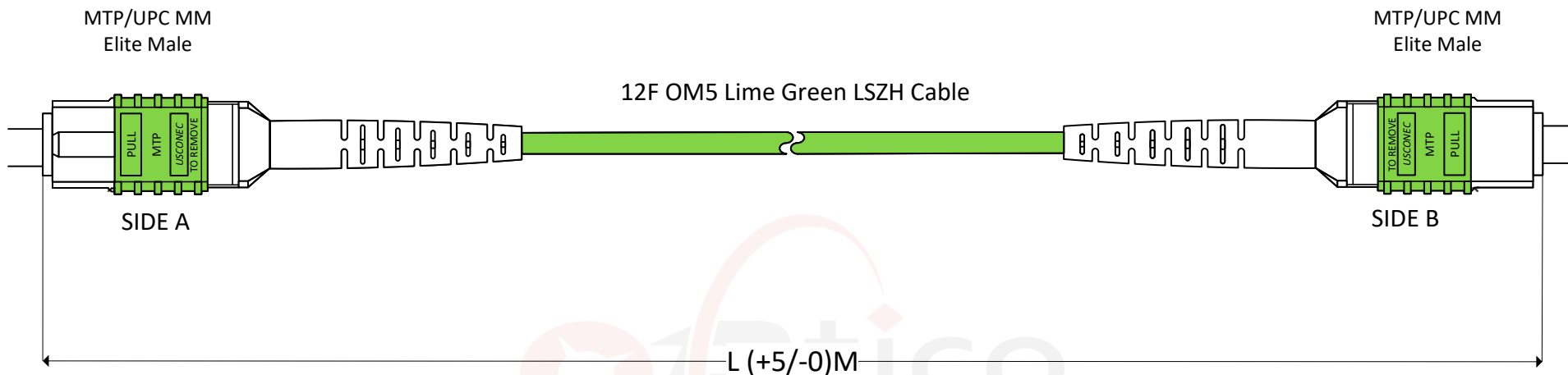

Type A (TIA)

Fiber No.		Color
SIDE A	SIDE B	
1	1	BLUE
2	2	ORANGE
3	3	GREEN
4	4	BROWN
5	5	GRAY
6	6	WHITE
7	7	RED
8	8	BLACK
9	9	YELLOW
10	10	VIOLET
11	11	PINK
12	12	AQUA

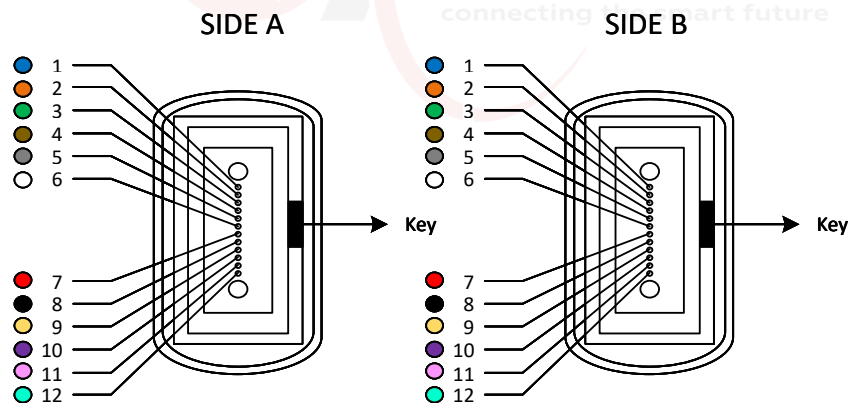

Specification:

- 1.Low Loss IL: $\leq 0.35\text{dB}$
- 2.Return Loss: $\geq 35\text{dB}$
- 3.Operation Environment: $-40\sim+85^{\circ}\text{C}$
- 4.Storage Environment: $-40\sim+85^{\circ}\text{C}$



SHENZHEN OPTICO COMMUNICATION CO., LTD.

Model	12F MTPUPC Male-MTPUPC Male Type A MM OM5 3.0mm Lime Green LSZH CPR-Dca Cable					OP-12F-MTPMUPC-FP-MM-A			
FIRST ANGLE PROJECTION	MATERIAL	UNIT	SCALE	SIZE	SHEET	DRAWN	XUELING W	DATE	2025.04.25
	LSZH	m	/	A4	1	CHECKED	Michael Liu	DATE	2025.04.25
						APPROVED	STEVEN Zhang	DATE	2025.04.25

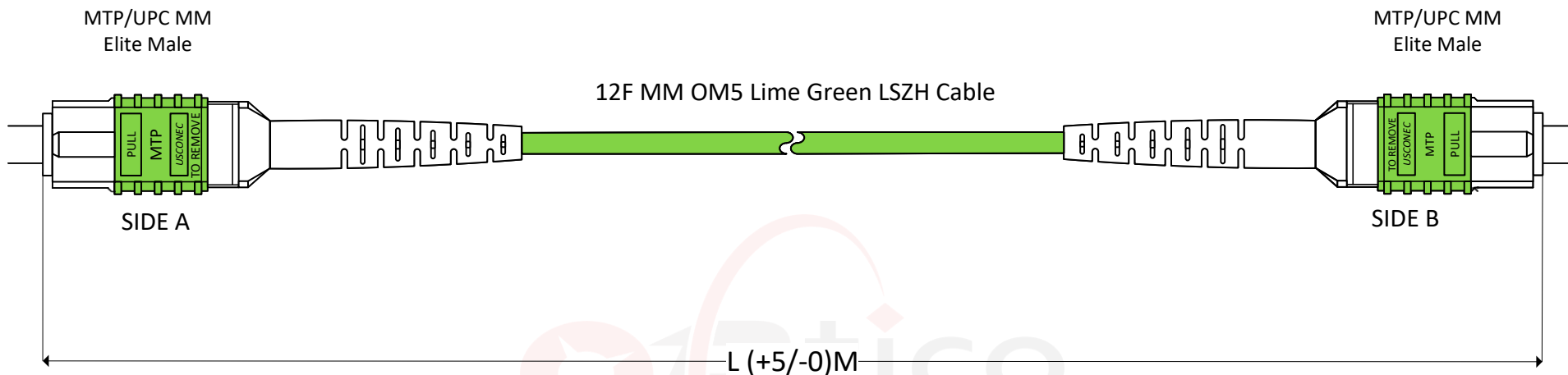

Type B (TIA)

Fiber No.		Color
SIDE A	SIDE B	
1	12	BLUE
2	11	ORANGE
3	10	GREEN
4	9	BROWN
5	8	GRAY
6	7	WHITE
7	6	RED
8	5	BLACK
9	4	YELLOW
10	3	VIOLET
11	2	PINK
12	1	AQUA

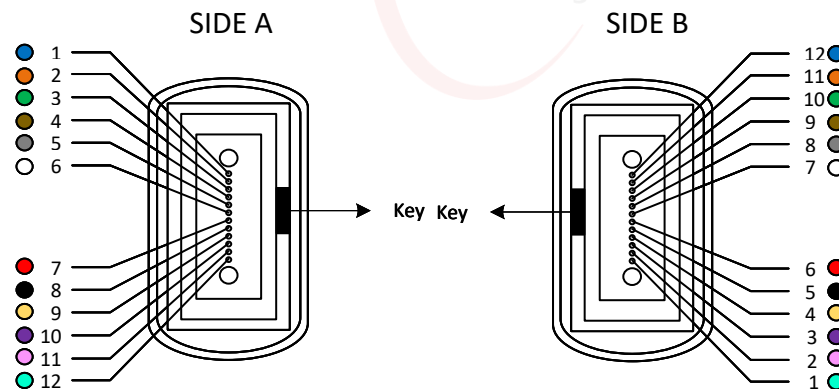

Specification:

- 1.Low Loss IL: $\leq 0.35\text{dB}$
- 2.Return Loss: $\geq 35\text{dB}$
- 3.Operation Environment: $-40\sim+85^{\circ}\text{C}$
- 4.Storage Environment: $-40\sim+85^{\circ}\text{C}$



SHENZHEN OPTICO COMMUNICATION CO., LTD.

Model	12F MTPUPC Male-MTPUPC Male Type B MM OM5 Lime Green LSZH CPR-Dca Cable					OP-12F-MTPMUPC-FP-MM-B			
FIRST ANGLE PROJECTION	MATERIAL	UNIT	SCALE	SIZE	SHEET	DRAWN	XUELING W	DATE	2025.04.25
	LSZH	m	/	A4	1	CHECKED	Michael Liu	DATE	2025.04.25
						APPROVED	STEVEN Zhang	DATE	2025.04.25